

CENTRIFUGES, CIRCLES, AND CANCER

By JEROME VINOGRAD

Molecular biology has among its goals the understanding of the molecular events that occur in living cells. Centrifugation, circular DNA, and cancer have played major roles in this exciting new science.

Centrifugation is one of the principal tools of the molecular biologist. It is used to isolate and characterize cellular macromolecules and organelles. Circular DNA, because of its well-defined size and the absence of ends, sharply tests our knowledge of the cell's machinery for replicating DNA and expressing its information. Although the problems of cancer—the causes and cures—appear to be awaiting new discoveries in the molecular biology of normal cells, we already know that there are abnormalities in the chromosomes of patients having certain types of leukemia. We also know that when tumor viruses such as *polyoma* transform normal mouse cells into malignant cells, the originally circular viral DNA becomes an integral part of a long strand of nuclear DNA.

About ten years ago, three years after Watson and Crick described the duplex (double-stranded) structure of DNA, Matthew Meselson, then a graduate student in chemistry, approached me with a problem. Could light and heavy DNA molecules, differing in mass by 1 to 2 percent, be separated in a centrifugation experiment? If so, could a hybrid molecule of DNA containing one light progeny strand and one heavy parental strand also be distinguished? The presence of such hybrid molecules in the DNA of an organism initially grown in a medi-

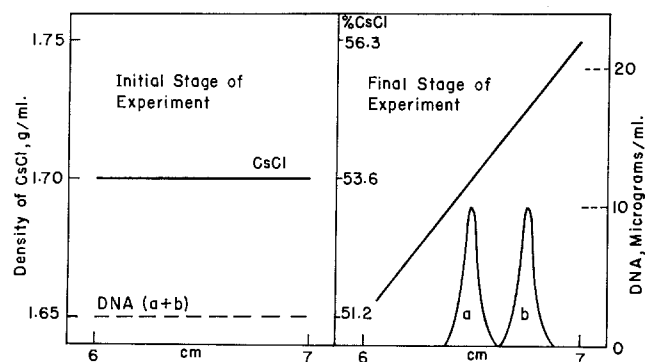

The results of a buoyant density experiment show how two DNA's (*a* and *b*), when centrifuged in a concentrated cesium chloride solution, move to regions of neutral buoyancy and form bands in the solution.

um containing heavy isotopes and then transferred for further growth to a medium containing normal isotopes would provide further direct evidence for the proposed duplex structure of DNA and for the Watson-Crick proposal that a DNA molecule replicates semi-conservatively (replicates, that is, to form two daughter molecules, each of which contains one of the original strands).

I replied that the resolving power of sedimentation velocity analyses as then practiced was inadequate, but that infinite resolution could be attained if one DNA species were held stationary while the other moved. I suggested that such a condition could be achieved by performing the sedimentation in concentrated salt solutions of high liquid density.

*Each experiment begins with a change in DNA. With delicate specificity
the machinery of the cell amplifies and channels each change
until it reaches its functional expression and its harsh trial,
subject to the verdict of survival and reproduction or failure and extinction.
Thus in the cumulative laboratory of evolution has arisen the whole intricate pattern of life
which the mind of man now attempts to unravel.
Some probe the DNA itself.*

Our first experiment—in the autumn of 1956 in the subbasement of Church Laboratory—reminded us that the salt itself, redistributing in the centrifugal field, would form a significant density gradient. In density gradients of this sort, DNA species move to regions of neutral buoyancy and there form bands. Dense DNA's form bands in the denser salt solution, and "light" DNA's form bands in the less dense salt solution. The transfer experiment, now thought of in terms of separating dense and less dense species as opposed to heavy and light masses, could clearly be done and was carried out by Meselson and Franklin W. Stahl in their now classic experimental validation of the Watson-Crick hypothesis.

The theory and practice of buoyant density centrifugation has, since its inception, been vigorously investigated in the Caltech laboratories. The density of the macromolecular complex at band center, a quantity now known as the buoyant density, is numerically equal to the density of the solution at band center and is readily measured with high precision and accuracy. Proteins, carbohydrates, DNA, and RNA exhibit widely different buoyant densities and are therefore very easily separated by this procedure. Nucleoproteins such as viruses normally form bands at densities that correspond to the weight fraction of the nucleic acid. DNA's of differing base composition have different buoyant densities. The buoyant method has become a favorite procedure for the analysis of the base composition

of DNA. The *Handbook of Biochemistry* lists the buoyant densities of some 300 DNA's from various organisms and viruses.

Our interest in circular duplex DNA arose in 1963 when Roger Weil and I and Renato Dulbecco and Marguerite Vogt discovered that the DNA in the tumor-inducing virus *polyoma* occurred in the form of a new DNA structure—a closed circular duplex without ends. The experiments that led to this con-

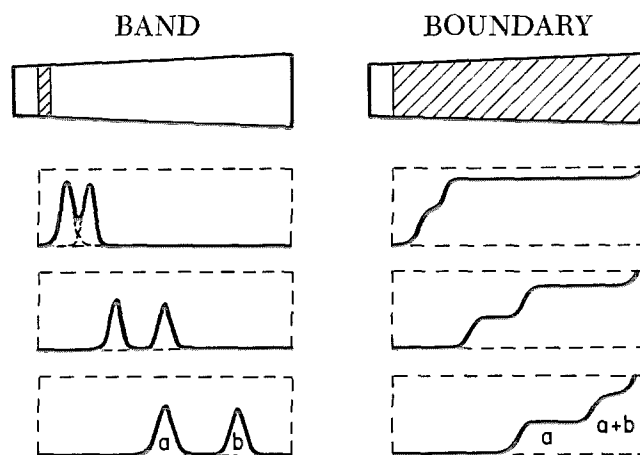

A comparison of the results of two methods of performing sedimentation velocity experiments shows the advantages of Caltech's new band method (left) over the boundary method (right). A smaller amount of DNA (indicated by striped lines) can be used. As sedimentation progresses (top to bottom frames), the concentration distributions of the DNA can be seen.

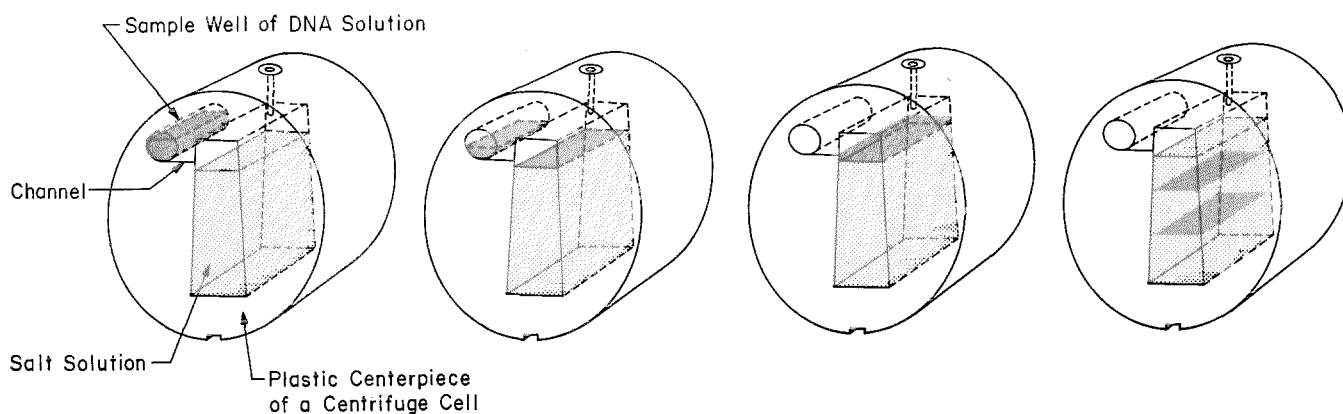

In a sedimentation velocity experiment a thin layer of a solution of DNA, stored in a sample well, flows out through a narrow channel under the influence of the centrifugal field and spreads out as a thin layer onto the surface of a salt solution. Diffusion of water from that layer into the slightly denser salt solution occurs rapidly and

forms the density gradient necessary for stabilizing the band of DNA as it sediments through the salt solution. Both the DNA sedimentation and the necessary gradient formation occur almost simultaneously. The last drawing shows the position of two bands of DNA during the experiment.

clusion were performed by a new method that we had just evolved for performing sedimentation velocity experiments with very small amounts of DNA. The new method, called *band sedimentation in self-generating density gradients*, had two significant advantages over the classical boundary sedimentation experiments. Smaller amounts of DNA could be used, and fairly large quantities of contaminants did not interfere. The procedures underlying this tricky method are illustrated above, and a typical set of results is shown below.

A band sedimentation experiment performed with a mixture of two variants of λ virus. Photographs of the rotating centrifuge cell taken at four-minute intervals show bands which contain about five billion viruses each.

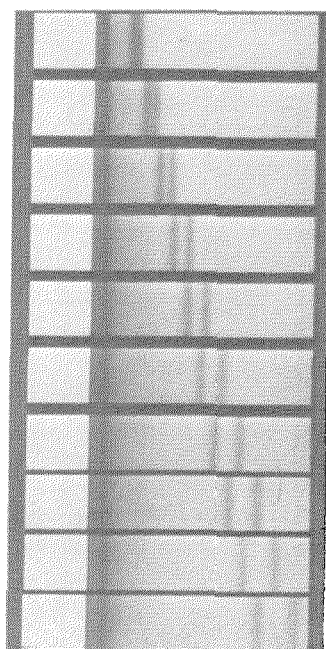

Closed circular duplex DNA consists of two, covalently closed, single-stranded DNA molecules that are interwound. The two strands share no atoms in primary bonding, yet they cannot be separated from each other without breaking a covalent bond. Such systems are said to contain a *topological bond*. Molecules containing interlocked circular submolecules are called catenanes. Organic chemists have enjoyed contemplating the various possibilities for stereoisomerism in catenanes. One catenane containing two rings of 30 carbons has been prepared and isolated. The DNA from *polyoma* virus contains approximately 5,000 nucleotides in each ring. The covalent backbone chains are interwound about 500 times to assume the normal DNA structure.

When closed duplex DNA is dissolved in common solvents, it assumes a structure in which the potential energy of the ensemble of atoms is at a minimum. The duplex winding number (the number of times one strand crosses over the other) in *polyoma* DNA, as in all other naturally occurring closed circular DNA's, turns out to be somewhat larger than the topological winding number obtained by counting the number of crossings when the helix axis lies in a plane. Although it is impossible to change the duplex winding number in a planar system, it can be changed if the helix axis is itself allowed to become helical so as to compensate exactly for the change in the duplex winding number. Closed circular DNA forms interwound superhelices, twisted molecules, in common solvents. The

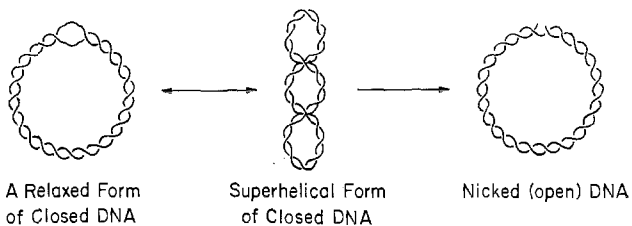

In these three forms of circular duplex DNA, the lines represent single strands of DNA. Closed circular DNA forms interwound superhelices (twisted molecules) in common solvents. The handedness of the superhelix allows us to conclude that the duplex was slightly underwound in the cell at the moment the last bond was formed.

handedness (the direction, clockwise or counterclockwise, in which the superhelix turns) of the superhelix allows us to conclude that the duplex was slightly underwound in the cell at the moment the last bond was formed (above).

Twisting of the molecule obviously requires an expenditure of energy which is partly stored in the molecule. The twisted molecule is like a spring, ready to unwind if the restraining forces are released. Untwisting occurs spontaneously if any one of 10,000 phosphate ester bonds in *polyoma* DNA is hydrolyzed. The duplex then spins around the rotatable chemical bonds in the intact strand opposite the single-strand break (the nick). The untwisted or relaxed molecule has a very different conformation. It moves through a solvent in band sedimentation experiments at a much slower rate

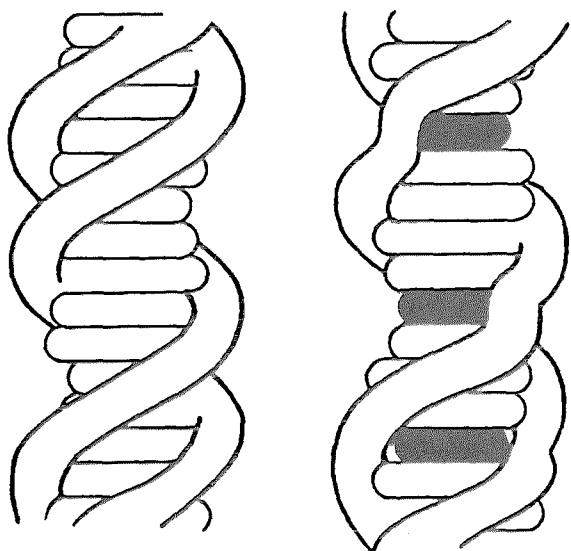

In this representation of two DNA molecules, the molecule on the right shows how drug (dye) molecules (black bands) are intercalated in the DNA molecule.

than the superhelical molecule. This effect is a useful tool in the study of the cell's machinery for "nicking" DNA—a process which must obviously occur if a closed circular molecule is to be replicated semi-conservatively.

The duplex DNA can be unwound in a controlled way by using any one of a set of intercalating dyes—dyes that slip in between base pairs of DNA. These intercalators force the base pairs of DNA apart and unwind the duplex slightly. The effects of the controlled addition of the drug ethidium bromide are exactly as predicted from our understand-

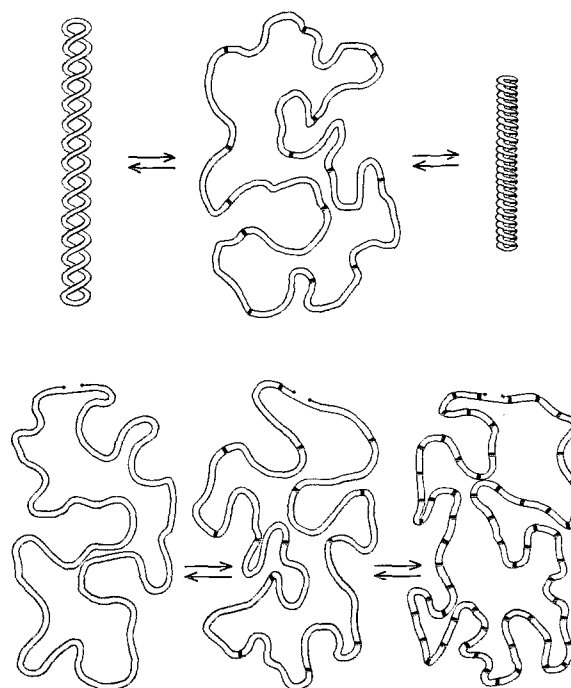

The effects of intercalating the drug ethidium bromide (black bands) into closed circular DNA are shown in the upper half of the diagram. First the drug relaxes the DNA, then it winds it up tighter. Binding the drug to nicked (open) circular DNA (lower part of the diagram) causes a rotation of the duplex at the site of the nick (the gap in the line). Each line represents a single strand of DNA.

ing of the topological properties of closed, double-stranded molecules. William Bauer, a Caltech graduate student in chemistry, recently showed that small amounts of this compound unwind and relax the intact molecule; larger amounts wind in superhelical turns that are left-handed instead of right-handed as in the native molecule. However, the nicked molecule merely spins at its rotation site, called a swivel, while binding the ethidium. It will

We are now faced with a large number of unsolved problems. Centrifugation, the chemistry of circular DNA, electron microscopy, hard work, and inspiration will all be needed to obtain solutions.

become saturated with the drug when one drug molecule is bound for every two base pairs. The relaxed DNA-ethidium complex will then have the appearance of a stack of sandwiches strung together in a circle, whereas closed molecules will wind up into a very tight spring with the free energy of spring formation opposing the binding of the ethidium. In consequence, less ethidium is bound by the closed molecules than by the nicked molecules.

The combination of the drug-binding by closed circular DNA and the buoyant density centrifugation method provides a very easy means to fish closed circular DNA out of mixtures which contain much larger amounts of linear DNA. The drug molecules are light and act like balloons attached to the denser DNA molecule. They cause the complex to move up in the gradient column to a region of lower density. The closed molecule, which takes up less drug, then has a higher buoyant density than do the

Three species of HeLa mitochondrial DNA are shown resolved in a cesium chloride-ethidium bromide density gradient. The dark upper band contains nicked (open) DNA, the narrow middle band contains singly nicked catenanes, the bottom band, closed DNA. The pale band in the lower part of the tube contains carbohydrate.

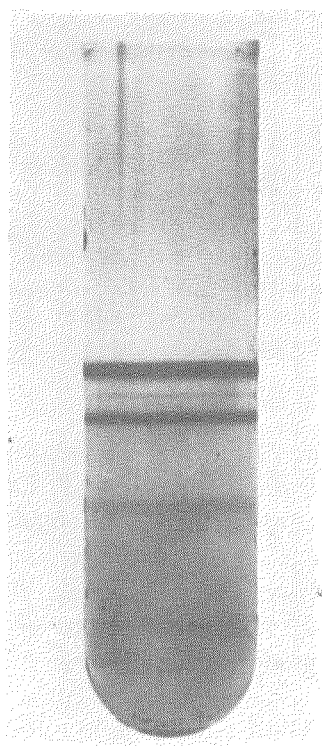

nicked or linear molecules. The bands shown in the test tube (below left) are easily separated into containers for further study.

This simple preparative method made it possible for us to investigate the occurrence and the properties of a type of closed circular DNA contained in almost all animal cells, beginning with protozoa and continuing to man. This particular DNA is contained in a cytoplasmic organelle called the mitochondrion. Mitochondria are responsible for the transfer of energy in oxidizable compounds to ATP (adenosine triphosphate), a key source of metabolic energy in the cell. The mitochondria are therefore often referred to as the cell's power plants. We do not yet understand why mitochondria have their own DNA genetic systems, spatially separated from the chromosomal DNA in the nucleus. Nor do we know the identity of the proteins specified by the information in the mitochondrial DNA. It is known, however, that certain genetic traits in yeast and molds are inherited through mitochondria.

When the mitochondrial DNA from the lower band in the test tube was examined in the electron microscope, Roger Radloff, formerly a Caltech graduate student in biology, made a surprising observation. Not only were there circles five microns in contour length (as had been reported by other researchers earlier), but there were also double, triple, and quadruple length circles in small amounts. Careful measurement of photographs of these molecules revealed crosspoints which divided the multiple length molecules into five micron subunits. Bruce Hudson, a graduate student in chemistry, showed that the double length molecules were catenated or interlocked pairs of closed circular duplexes. Such molecules are properly called catenated catenanes. If one submolecule is nicked and the other is closed, the restriction on drug-binding will be only half as large as in a simple closed molecule. The middle band in the test tube was highly enriched in singly nicked catenated dimers.

These structural studies were performed with

mitochondrial DNA obtained from HeLa cells, a line of human cancer cells that have been grown in tissue culture for more than 25 years. The biological implications of the interlocking of two or more sets of mitochondrial genes were puzzling. It was obvious, however, that we should try to find whether these structures were unique to HeLa cells or whether they occurred also in the mitochondria of normal and malignant tissues that had not been grown in tissue culture.

The first phase of this population survey is now almost complete and has taken a surprising turn. David Clayton, a graduate student in biology, has found that a large fraction of the mitochondrial DNA in the circulating white cells of patients with granulocytic leukemia are in the form of double length molecules that appear to have exactly twice the contour length of monomeric mitochondrial DNA (right). We call this kind of molecule a circular dimer, and tentatively we think of it as a villain. Chemotherapy appears to reduce the frequency of the circular dimer by a factor of about five. My collaborators, David Clayton, John Jordan, Charles A. Smith, Marlyn Teplitz, and Eric Wickstrom, have searched diligently but without success for a circular dimer among thousands of mitochondrial DNA molecules from various organs of healthy rabbits, guinea pigs, and rats. The circular dimer is also absent in mitochondrial DNA from immature, circulating white cells of patients with nonmalignant maladies that give rise to high white blood cell counts. In the course of this search we have, however, found catenanes in varying frequencies from 3 to 9 percent in every one of the mitochon-

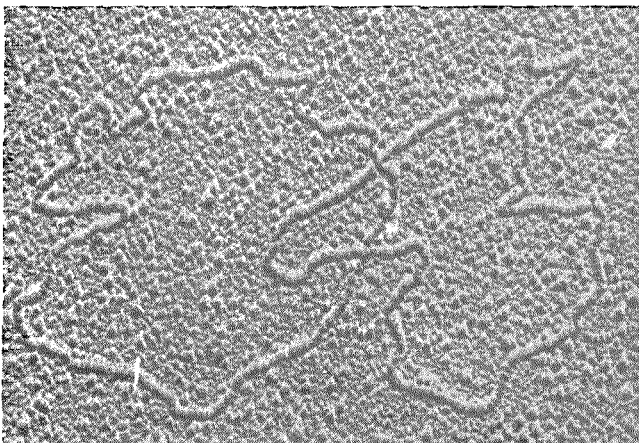

This electron micrograph shows a catenated mitochondrial DNA molecule from a human cell. The submolecules are connected like closed links in a chain.

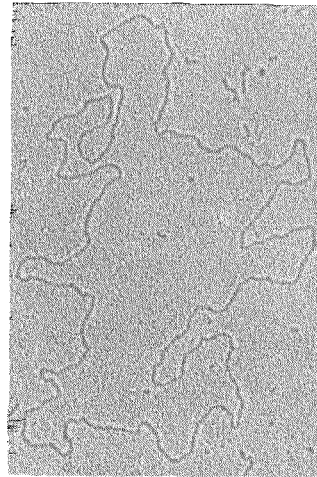
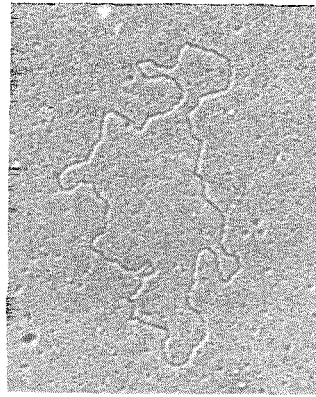

Electron micrographs of mitochondrial DNA from human leukemic white cells show (upper) a circular monomer five microns in contour length and (lower) a ten-micron circular dimer.

drial DNA samples. It may safely be said that catenanes are normal constituents of our cells.

We are now faced with a large number of unsolved problems. What is the mitochondrial DNA distribution in other kinds of leukemia and in solid tumors? How are the catenanes and circular dimers formed in the cell? How does the cell control their frequency? Do these molecules represent precise duplications of the mitochondrial DNA genes? If so, are excess gene products (proteins) formed? Are abnormal gene products formed? Finally, are we any closer to understanding the cancer problem? Is the correlation that we have so far observed between the occurrence of the circular dimer and granulocytic leukemia trivial or meaningful? Is the change in the size of the molecule an early event in an undifferentiated cell which gives rise after many cell divisions to white cells that do not mature properly and do not go about their job in an orderly and controlled way? Centrifugation, the chemistry of circular DNA, electron microscopy, hard work, and inspiration will all be needed to obtain answers to these questions. □